

**Driver LC 45W 1050mA fixC SR SNC**  
ESSENCE series

**Product description**

- Independent fixed output LED Driver
- Constant current LED Driver
- Output current 1,050 mA
- Max. output power 45 W
- Nominal life-time up to 50,000 h
- For luminaires of protection class I and protection class II
- Temperature protection as per EN 61347-2-13 C5e
- 5-year guarantee

**Properties**

- Casing: polycarbonat, white
- Type of protection IP20

**Functions**

- Overtemperature protection
- Overload protection
- Short-circuit protection
- No-load protection



**Standards**, page 3

**Wiring diagrams and installation examples**, page 4



IP20 SELV   

### Driver LC 45W 1050mA fixC SR SNC

ESSENCE series

#### Technical data

Rated supply voltage	220 – 240 V
AC voltage range	198 – 264 V
Mains frequency	50 / 60 Hz
Overvoltage protection	320 V AC, 1 h
THD (at 230 V, 50 Hz, full load)	< 20 %
Output current tolerance <sup>®</sup>	± 7.5 %
Typ. current ripple (at 230 V, 50 Hz, full load)	± 30 %
Turn on time (at 230 V, 50 Hz, full load)	≤ 0.5 s
Turn off time (at 230 V, 50 Hz, full load)	≤ 0.5 s
Hold on time at power failure (output)	0 s
Ambient temperature ta	-20 ... +50 °C
Ambient temperature ta (at life-time 50,000 h)	40 °C
Storage temperature ts	-40 ... +80 °C
Dimensions L x W x H	130 x 68 x 31 mm

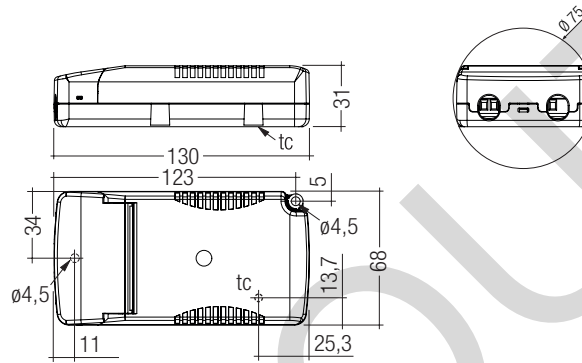

#### Ordering data

Type <sup>®</sup>	Article number	Packaging, carton	Packaging, low volume	Packaging, high volume	Weight per pc.
LC 45W 1050mA fixC SR SNC	87500552	30 pc(s).	390 pc(s).	1950 pc(s).	0.152 kg

#### Specific technical data

Type	Output current <sup>®</sup>	Input current (at 230 V, 50 Hz, full load)	Max. input power	Typ. power consumption (at 230 V, 50 Hz, full load)	Output power range	$\lambda$ at full load <sup>®</sup>	Efficiency at full load <sup>®</sup>	$\lambda$ at min. load <sup>®</sup>	Efficiency at min. load <sup>®</sup>	Min. forward voltage	Max. forward voltage	Max. output voltage	Max. output current at full load <sup>®</sup>	Max. output peak current at min. load <sup>®</sup>	Max. casing temperature tc
LC 45W 1050mA fixC SR SNC	1,050 mA	0,225 A	51 W	50 W	31.5 – 45.0 W	0.96	90.5 %	0.94C	89.5 %	30 V	43 V	54 V	1,470 mA	1,680 mA	90 °C

<sup>®</sup> Test result at 230 V, 50 Hz.

<sup>®</sup> The trend between min. and full load is linear.

<sup>®</sup> Output current is mean value.

**Standards**

- EN 55015
- EN 61000-3-2
- EN 61000-3-3
- EN 61347-1
- EN 61347-2-13
- EN 61547

**Overload protection**

If the output voltage range is exceeded the LED Driver will protect itself and LED may flicker. After elimination of the overload, the nominal operation is restored automatically.

**Overtemperature protection**

The LED Driver is protected against temporary thermal overheating. If the temperature limit is exceeded, the output current is reduced to limit  $t_c$  at a certain level.  
The temperature protection is activated typically at 10 °C above  $t_c$  max.

**Short-circuit behaviour**

In case of a short circuit on the secondary side (LED) the LED Driver switches into hic-cup mode. After elimination of the short-circuit fault the LED Driver will recover automatically.

**No-load operation**

The LED Driver works in burst working mode to provide a constant output voltage regulation which allows the application to be able to work safely when LED string opens due to a failure.

**Installation instructions**

The LED module and all contact points within the wiring must be sufficiently insulated against 3 kV surge voltage.  
Air and creepage distance must be maintained.

**Replace LED module**

1. Mains off
2. Remove LED module
3. Wait for 10 seconds
4. Connect LED module again

Hot plug-in or secondary switching of LEDs is not permitted and may cause a very high current to the LEDs.

**Expected life-time**

Type	$t_a$	40 °C	50 °C	60 °C
<b>LC 45W 1050mA fixC SR SNC</b>	$t_c$	80 °C	90 °C	x
	Life-time	50,000 h	30,000 h	x

The LED Drivers are designed for a life-time stated above under reference conditions and with a failure probability of less than 10 %.

**Maximum loading of automatic circuit breakers**

Automatic circuit breaker type	C10	C13	C16	C20	B10	B13	B16	B20	Inrush current
Installation $\varnothing$	1.5 mm <sup>2</sup>	1.5 mm <sup>2</sup>	1.5 mm <sup>2</sup>	2.5 mm <sup>2</sup>	1.5 mm <sup>2</sup>	1.5 mm <sup>2</sup>	1.5 mm <sup>2</sup>	2.5 mm <sup>2</sup>	$I_{max}$ Time
<b>LC 45W 1050mA fixC SR SNC</b>	35	45	55	70	30	45	55	65	10 A 100 $\mu$ s

**Harmonic distortion in the mains supply (at 230 V / 50 Hz and full load) in %**

	THD	3.	5.	7.	9.	11.
<b>LC 45W 1050mA fixC SR SNC</b>	20	12	2	1	1	1

**Fixing conditions**

Dry, acidfree, oilfree, fatfree. It is not allowed to exceed the maximum ambient temperature ( $t_a$ ) stated on the device. Minimum distances stated below are recommendations and depend on the actual luminaire. Is not suitable for fixing in corner.

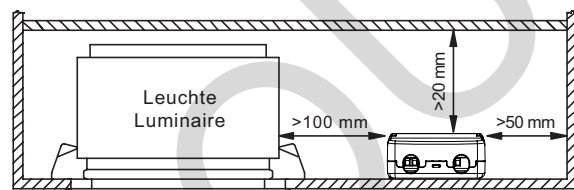

**Glow-wire test**

according to EN 61347-1 with increased temperature of 850 °C passed.

**Mounting of device**

Max. torque for fixing: 0.5 Nm/M4

**Conditions of use and storage**

Humidity: 5 % up to max. 85 %, not condensed (max. 56 days/year at 85 %)

Storage temperature: -40 °C up to max. +80 °C

The devices have to be within the specified temperature range ( $t_a$ ) before they can be operated.

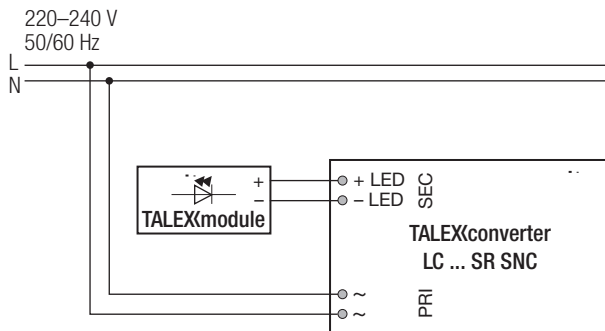
**Wiring diagram****Isolation and electric strength testing of luminaires**

Electronic devices can be damaged by high voltage. This has to be considered during the routine testing of the luminaires in production.

According to IEC 60598-1 Annex Q (informative only!) or ENEC 303-Annex A, each luminaire should be submitted to an isolation test with 500 V<sub>DC</sub> for 1 second. This test voltage should be connected between the interconnected phase and neutral terminals and the earth terminal. The isolation resistance must be at least 2 MΩ.

As an alternative, IEC 60598-1 Annex Q describes a test of the electrical strength with 1500 V<sub>AC</sub> (or 1.414 x 1500 V<sub>DC</sub>). To avoid damage to the electronic devices this test must not be conducted.

**Additional information**

Additional technical information at [www.tridonic.com](http://www.tridonic.com) → Technical Data

Guarantee conditions at [www.tridonic.com](http://www.tridonic.com) → Services

Life-time declarations are informative and represent no warranty claim. No warranty if device was opened.

**Wiring type and cross section**

The wiring can be in stranded wires with ferrules or solid.

For perfect function of the cage clamp terminals the strip length should be 4 – 5 mm for the input terminal.

The max. torque at the clamping screw (M3) is 0.2 Nm.

Use one wire for each terminal connector only.

Use each strain relief channel for one cable only.

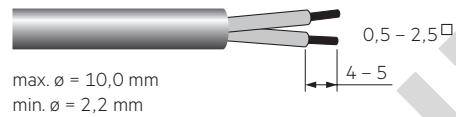
**Input / Output terminal****Wiring instructions**

The secondary leads should be separated from the mains connections and wiring for good EMC performance.

The maximum lead length on secondary side is 2 m.

For a good EMC performance keep the LED wiring as short as possible.

**Wiring guidelines**

- All connections must be kept as short as possible to ensure good EMI behaviour.
- Mains leads should be kept apart from LED control gear and other leads (ideally 5 – 10 cm distance)
- Max. length of output wires is 2 m.
- Secondary switching is not permitted.
- Incorrect wiring can damage LED modules.
- To avoid the damage of the Driver, the wiring must be protected against short circuits to earth (sharp edged metal parts, metal cable clips, louver, etc.).

**Diagrams LC 45W 1050mA fixC SR SNC**

Efficiency vs load

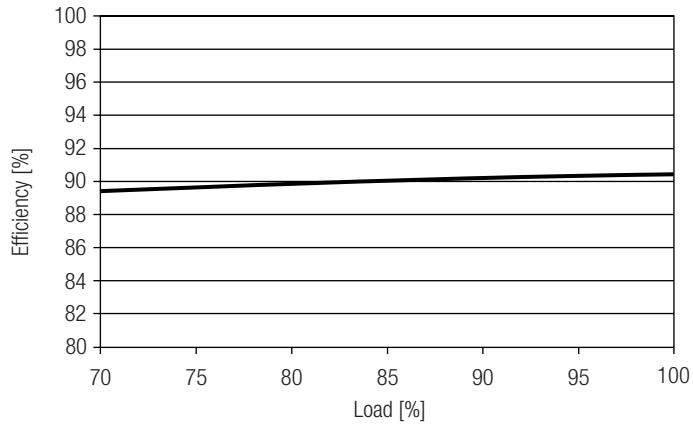

Power factor vs load

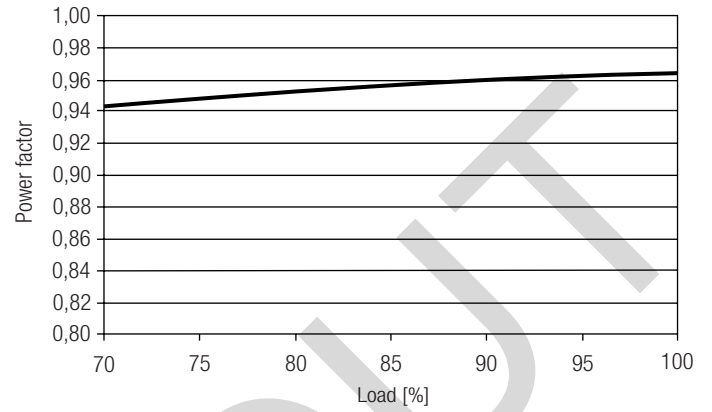

Input power vs load

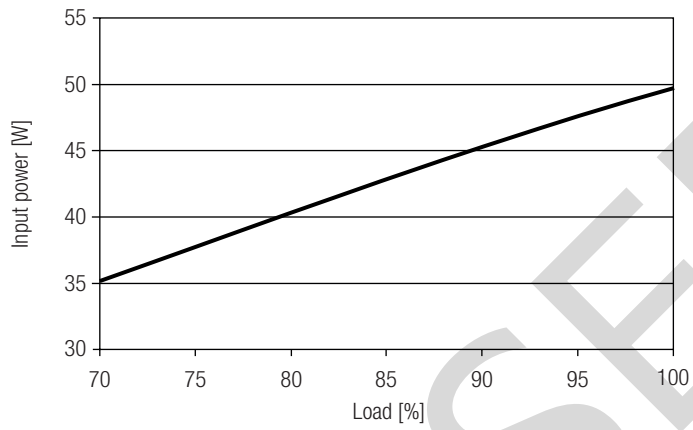

Input current vs load

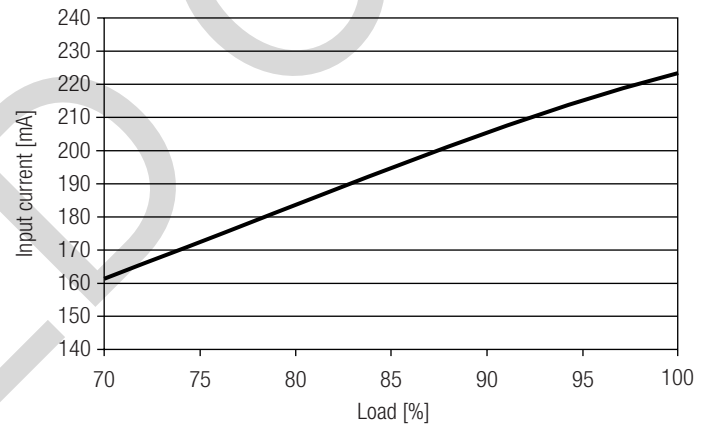

THD vs load

